

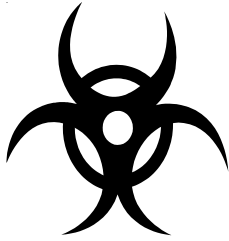

PREMIER PUMP & SUPPLY, INC.

PROVIDING YOU WITH THE VERY BEST SERVICE IN THE INDUSTRY!



Smart Flow F-700 SERIES 200-240-480V VARIABLE FREQUENCY PUMP DRIVE

RATINGS: Pump-Variable-Constant Torque

**240V F720 SERIES 1 THRU 200 HORSEPOWER
480V F740 SERIES 1 THRU 800 HORSEPOWER**



APPROVALS:

*UL508c

DESIGN:

*Smallest Possible Package For Variable Frequency Drive, Input Disconnect & Fuses

*Thermostatic Controlled Ventilation

*White High Quality Powder Coated

*Heavy Duty Steel

*Nema 3R Enclosure
Suitable for side by side mounting

OPERATING CONDITIONS:

*Input Voltage

*240Volt
Tolerance: 170-264V @ 60Hz

*480Volt
Tolerance: 323-528V-50-60Hz-1-100HP
Tolerance: 323-550V-50-60Hz-150-800HP

*Ambient Temperature
-10C to 50C

Humidity 90%RH or less non-condensing

*Altitude 3300 ft. higher with derating
No derating for carrier freq. change

OPTIONS:

*Express Delivery

*Circuit Breaker

*NEMA 4 - 4x - 12 Enclosure

*3 - Contactor By-Pass

*Input-Output Reactors

*Water to Air Heat
Exchanger

*Air Condition

*Custom Control Integration

SmartFlow package systems is our solution to faster deliveries for standard configurations and modified standard engineered VFD drive packages. Unique options, requirements, and modifications are our speciality

PAGE NEW - 1
SEPTEMBER - 2009



PREMIER PUMP & SUPPLY, INC.

PROVIDING YOU WITH THE VERY BEST SERVICE IN THE INDUSTRY!

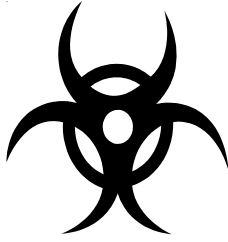

Smart Flow F-700 SERIES 200-240-480V VARIABLE FREQUENCY PUMP DRIVE PART NUMBER CONFIGURATION

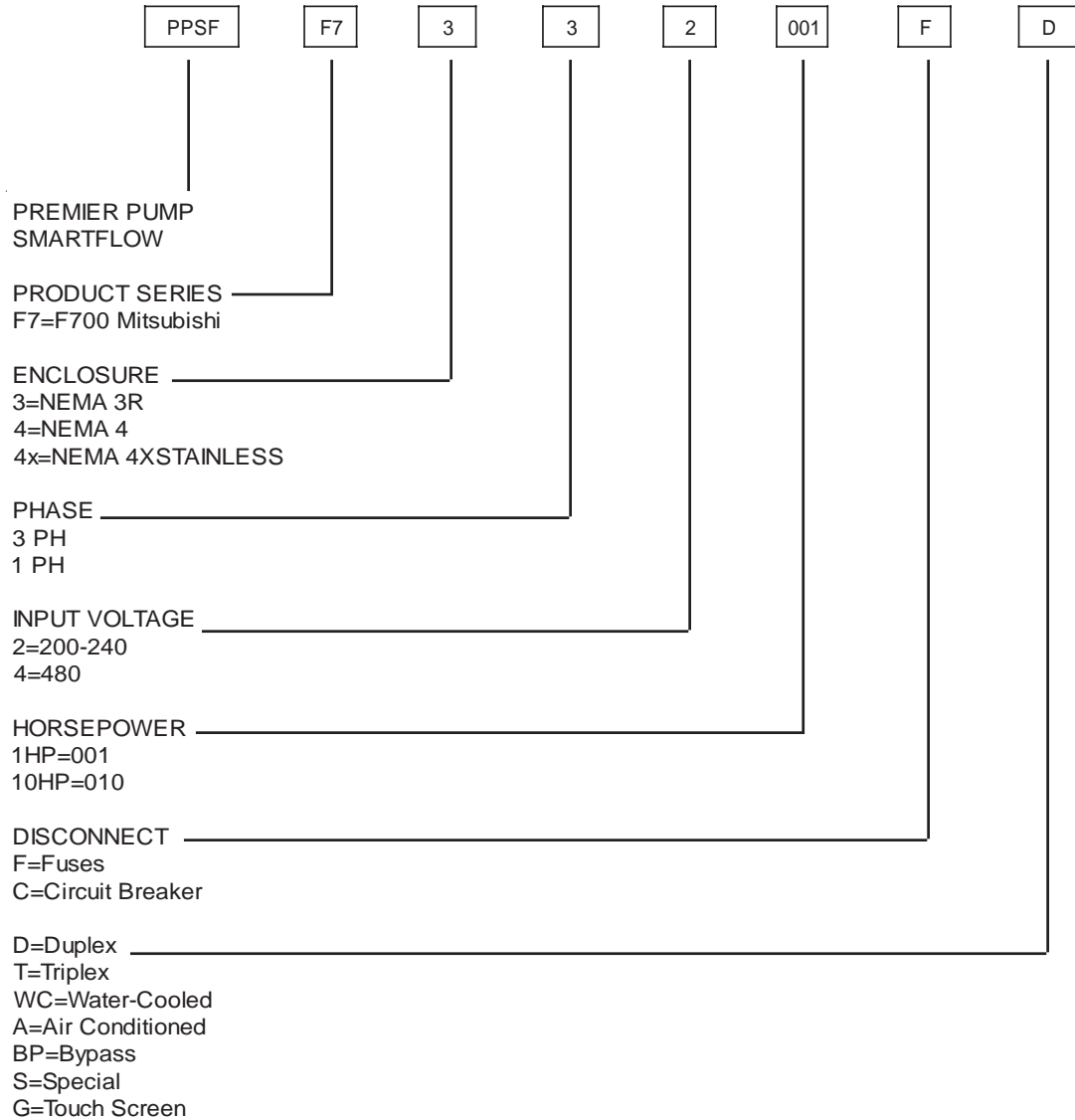

PAGE NEW - 2
SEPTEMBER - 2009



PREMIER PUMP & SUPPLY, INC.

PROVIDING YOU WITH THE VERY BEST SERVICE IN THE INDUSTRY!

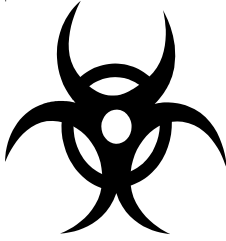

Smart Flow F-700 SERIES 200-240-480V VARIABLE FREQUENCY PUMP DRIVE

NEMA-3R 1 PHASE 240V FUSED DISCONNECT

COMPLETE NEMA 3R METAL ENCLOSURE WITH TOUCH SCREEN & 3R WINDOW

PART #	FLA	ENC	VOLTAGE	H-W-D LBS	LIST PRICE
PPSFF7312005FG	20.4	N-3R	240	25 x 16 x 14.9 87lbs	7280.00
PPSFF7312007FG	29.4	N-3R	240	25 x 16 x 14.9 87lbs	7923.00
PPSFF7312010FG	37.8	N-3R	240	25 x 16 x 14.9 87lbs	9400.00
PPSFF7312015-20FG	46.3	N-3R	240	34 x 19 x 12 160lbs	10506.00

SIZE DRIVE PER FULL LOAD AMPS OF THE MANUFACTURES MOTOR
OTHER SIZES AVAILABLE - CALL FOR QUOTE

NEMA-3R 3 PHASE 200-240V FUSED DISCONNECT

COMPLETE NEMA 3R METAL ENCLOSURE WITH TOUCH SCREEN & 3R WINDOW

PART #	FLA	ENC	VOLTAGE	H-W-D LBS	LIST PRICE
PPSFF7332005FG	12.1-16.7	N-3R	200-240	20 x 14 x 14 65lbs	6266.00
PPSFF7332007FG	18.3-25.0	N-3R	200-240	25 x 16 x 14.9 87lbs	7188.00
PPSFF7332010FG	24.8-34.0	N-3R	200-240	25 x 16 x 14.9 87lbs	7372.00
PPSFF7332015-20FG	35.9-49.0	N-3R	200-240	25 x 16 x 14.9 87lbs	8386.00
PPSFF7332020-25FG	46.2-63.0	N-3R	200-240	34 x 19 x 12.0 160lbs	9215.00
PPSFF7332025-30FG	56.0-77.0	N-3R	200-240	34 x 19 x 12.0 160lbs	10320.00

SIZE DRIVE PER FULL LOAD AMPS OF THE MANUFACTURES MOTOR
OTHER SIZES AVAILABLE - CALL FOR QUOTE

PAGE NEW - 3
FEBRUARY - 2011



PREMIER PUMP & SUPPLY, INC.

PROVIDING YOU WITH THE VERY BEST SERVICE IN THE INDUSTRY!

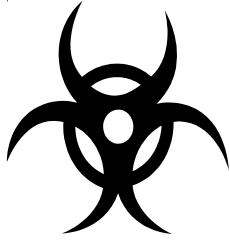

Smart Flow F-700 SERIES 200-240-480V VARIABLE FREQUENCY PUMP DRIVE

NEMA 3R 3 PHASE 480V FUSED DISCONNECT

COMPLETE NEMA 3R METAL ENCLOSURE WITH TOUCH SCREEN & 3R WINDOW

PART #	FLA	ENC	VOLTAGE	H-W-D LBS	LIST PRICE
PPSFF7334005FG	6.0-8.3	N-3R	480	20 x 14 x 14 65lbs	6357.00
PPSFF7334007FG	9.2-12.6	N-3R	480	20 x 14 x 14 65lbs	6817.00
PPSFF7334010FG	12.4-17.0	N-3R	480	25 x 16 x 14.9 87lbs	7686.00
PPSFF7334010-20FG	18.3-25.0	N-3R	480	25 x 16 x 14.9 87lbs	7740.00
PPSFF7334015-25FG	22.7-31.0	N-3R	480	25 x 16 x 14.9 87lbs	7926.00
PPSFF7334020-30FG	27.8-38.0	N-3R	480	34 x 19 x 12 160lbs	10320.00
PPSFF7334025-40FG	34.4-47.0	N-3R	480	34 x 19 x 12 160lbs	11611.00
PPSFF7334050FG	45.4-62.0	N-3R	480	34 x 19 x 12 160bs	12715.00
PPSFF7334060FG	56.0-77.0	N-3R	480	42 x 30 x 15 275lbs	17277.00
PPSFF7334060FGFS	56.0-77.0	N-3R	480	42 x 30 x 15 275lbs	17906.00
PPSFF7334075FG	68.0-93.0	N-3R	480	42 x 30 x 15 275lbs	17572.00
PPSFF7334075FGFS	68.0-93.0	N-3R	480	42 x 30 x 15 275lbs	18200.00
PPSFF7334100FG	84.0-116.0	N-3R	480	42 x 30 x 15 275lbs	20149.00
PPSFF7334100FGFS	84.0-116.0	N-3R	480	42 x 30 x 15 275lbs	20777.00

FS=FLOOR STANDS

**SIZE DRIVE PER FULL LOAD AMPS OF THE MANUFACTURES MOTOR
OTHER SIZES AVAILABLE - CALL FOR QUOTE**

PAGE NEW - 4
FEBRUARY - 2011



PREMIER PUMP & SUPPLY, INC.

PROVIDING YOU WITH THE VERY BEST SERVICE IN THE INDUSTRY!

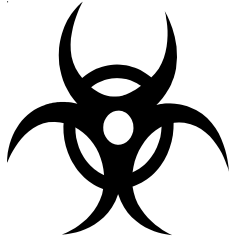

Smart Flow F-700 SERIES 200-240-480V VARIABLE FREQUENCY PUMP DRIVE ACCESSORIES

SERIES: 628

PRESSURE RANGE: 0-150PSI

HOUSING: CONDUIT HOUSING

TRANSDUCER CONNECTION: 1/4"NPT

ELECTRICAL CONNECTION: 1/2" FEMALE NPT CONDUIT

SIGNAL OUTPUT: 4-20mA

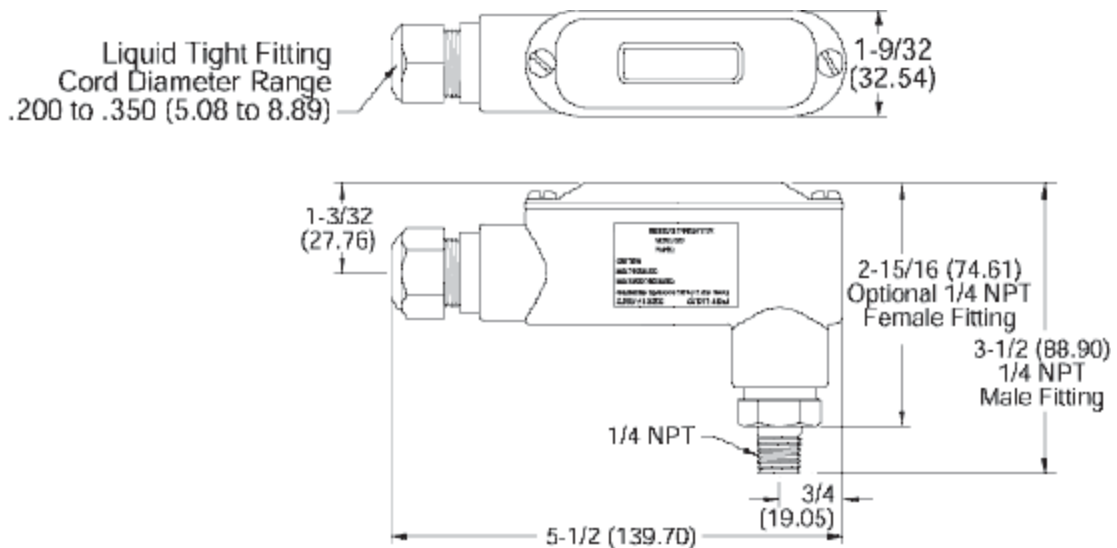

PART #	DESCRIPTION	LIST PRICE
628-11-CHP1-E5-S1	0-150 PSI TRANSDUCER	220.00
95218-05-09	TRANSDUCER CABLE PER FOOT	1.28

PAGE NEW - 5
JUNE - 2010

*CHICO- (800) 342-6022 FAX (530) 342-6636 *FRESNO (800) 538-4100 FAX (559) 834-6800

*RANCHO CORDOVA (800) 248-5225 FAX (916) 638-0344 *SANTA ROSA (888) 899-3565 FAX (707) 573-0308

*TURLOCK (866) 669-0220 FAX (209) 669-0202 *SAN BERNARDINO (877) 796-8181 FAX (909) 799-8118