





DRILLING FLUIDS

| PRODUCT | DESCRIPTION | NET | NET QTY. | PALLET QTY. |
|---|---|-------|----------|-------------|
| EXTRA HIGH YIELD GEL  | PREMIUM GRADE WYOMING BENTONITE IN 50# MULTI - WALLED BAGS. | 8.65 | 8.00 | 60 BAGS |
| ENVIROPLUG  | HIGH SWELLING, NSF APPROVED, CHEMICALLY UNALTERED BENTONITE IN 50# BAGS. | | | |
| MEDIUM | 1/4" TO 3/8" SIZE CHIPS | 8.85 | 8.20 | 60 BAGS |
| COARSE | 3/8" TO 3/4" SIZE CHIPS | 8.85 | 8.20 | 60 BAGS |
| 8 MESH | 97% 4 MESH - MONTMORILLONITE CLAY | 8.80 | 8.15 | 60 BAGS |
| 16 MESH | 97% 8 MESH - MONTMORILLONITE CLAY | 8.80 | 8.15 | 60 BAGS |
| TIME DELAY COATED PELLETS | 3/8" BENTONITE PELLETS SPECIFICALLY COATED TO DELAY ITS HYDRATION & SWELLING #50 BUCKETS | 86.50 | 80.00 | 10 BUCKETS |
| ENVIROPLUG GROUT  | SPECIALLY FORMULATED HIGH - SOLIDS BENTONITE GROUT FOR SEALING APPLICATIONS IN 50# MULTI - WALLED BAGS. MIX 50# WITH 14 GAL. OF WATER AND IT WILL YIELD 2.27 CU. FT. OF 30% SOLIDS. | 19.00 | 17.60 | 48 BAGS |
| GROUTWELL | BENTONITE GROUT FOR SEALING APPLICATIONS IN 50# MULTI - WALLED BAGS. MIX 50# WITH 28 GAL. OF WATER AND IT WILL YEILD 31 GALLONS OF 17.7% SOLIDS GROUT. | 15.00 | 13.90 | 60 BAGS |
| GROUTWELL-DF | SAME AS GROUTWELL EXCEPT IT IS A GRANULAR PRODUCT TO REDUCE DUST | 15.20 | 14.10 | 60 BAGS |
| TRU-BORE | HIGHLY CONCENTRATED BENTONITE-BASED DRILLING FLUID FOR DIFFICULT VERTICAL AND HORIZONTAL DRILLING. PACKAGED IN 50# MULTI-WALLED BAGS. | 11.50 | 10.65 | 60 BAGS |



PREMIER PUMP & SUPPLY, INC.

PROVIDING YOU WITH THE VERY BEST SERVICE IN THE INDUSTRY!



Economy MUD PRODUCTS CO.

| PRODUCT | DESCRIPTION | NET. |
|--------------|--|--------|
| KWIK-VIS "D" | PREMIUM DRY GRANULAR POLYMER PACKAGED IN (3) 12LB JUGS PER CASE | 291.50 |
| WYO-VIS | HIGH PERFORMANCE VISCOSIFIER, FAST ACTING LIQUID FORMULA PACKAGED IN (4) 1 GALLON JUGS PER CASE | 116.50 |
| WYO-FOAMER | HIGHLY CONCENTRATED FOAMING AGENT PACKAGED IN 5 GALLON CONTAINER | 111.00 |
| THINZ-IT | HIGHLY CONCENTRATED NON-TOXIC THINNING AGENT PACKAGED IN 5 GALLON PLASTIC PAIL | 199.50 |

PAGE D - 2
APRIL - 2011



LONESTAR SAND

| DESCRIPTION | NET PRICE |
|-------------------------------|-----------|
| #3 LONESTAR SAND (8/20) | 11.75 |
| #2/12 LONESTAR SAND (12/20) | 11.75 |
| 100# BAG - 35 PER PALLET | |

**** STOCKED IN FRESNO ONLY**

PAGE D - 3
JUNE - 2010



BELL - END WELL CASING ASTM F480

| CRESLINE LIFT QUANTITY | PW LIFT QUANTITY | DIAMETER AND TYPE | BROKEN LIFT NET PER/ 100' | FULL LIFT NET PER/ 100' |
|------------------------|------------------|-------------------|--|-------------------------|
| 760' | 760' | 5" SDR-21 | PLEASE CALL FOR CURRENT PRICES ON WELL CASING DUE TO UNSTABLE MARKET | |
| 760' | 760' | 5" SDR-26 | | |
| 360' | 520' | 6" SDR-21 | | |
| 360' | 520' | 6" SDR-26 | | |
| 280' | 300' | 8" SDR-21 | | |
| 280' | 300' | 8" SDR-26 | | |
| - | 240' | 10" SDR-21 | | |
| - | 240' | 10" SDR-26 | | |
| - | 120' | 12" SDR-21 | | |
| - | 120' | 12" SDR-26 | | |

SDR - 21 CLASS 200
 SDR - 26 CLASS 160

SPECIAL " NET " PRICES FOR 1/2 TRUCK LOAD QUANTITY / DROP SHIP

CALL FOR QUOTE

PRICES ARE SUBJECT TO CHANGE WITHOUT NOTICE

PAGE D - 4
 FEBRUARY - 2008



THREADED WELL CASING ASTM F480

| LIFT QUANTITY | DIAMETER AND TYPE | BROKEN LIFT NET PER/ 100' | FULL LIFT NET PER/ 100' |
|---------------|-------------------|---------------------------|-------------------------|
| 640' | 4.5" SDR-26 | CALL FOR PRICES | |
| 560' | 5" SDR-21 | | |
| 560' | 5" SDR-26 | | |
| 480' | 6" SDR-21 | | |
| 480' | 6" SDR-26 | | |

SDR - 21 CLASS 200
 SDR - 26 CLASS 160

SPECIAL " NET " PRICES FOR 1/2 TRUCK LOAD QUANTITY / DROP SHIP

CALL FOR QUOTE

PRICES ARE SUBJECT TO CHANGE WITHOUT NOTICE

*CHICO- (800) 342-6022 FAX (530) 342-6636 *FRESNO (800) 538-4100 FAX (559) 834-6800
 *RANCHO CORDOVA (800) 248-5225 FAX (916) 638-0344 *SANTA ROSA (888) 899-3565 FAX (707) 573-0308
 *TURLOCK (866) 669-0220 FAX (209) 669-0202 *SAN BERNARDINO (877) 796-8181 FAX (909) 799-8118



PREMIER PUMP & SUPPLY, INC.
 PROVIDING YOU WITH THE VERY BEST SERVICE IN THE INDUSTRY!



Quality ground water monitoring products since 1973

| FLUSH THREAD CASING - PVC - SCHEDULE 40 | | | | | |
|---|----------------|----------|------------------|-------------------|-----------------|
| SIZE IN INCHES | LENGTH IN FEET | BOX QTY. | SINGLES NET EACH | BOX QTY. NET EACH | WEIGHT LBS. EA. |
| 1 | 5 | 6 | 11.78 | 10.58 | 1.5 |
| 1 | 10 | 6 | 24.07 | 16.29 | 3.1 |
| 2 | 2 1/2 | 6 | 12.80 | 11.08 | 1.6 |
| 2 | 5 | 6 | 17.06 | 14.74 | 3.3 |
| 2 | 10 | 6 | 31.49 | 22.71 | 6.5 |
| 4 | 2 1/2 | 2 | 33.60 | 29.41 | 4.7 |
| 4 | 5 | 2 | 46.02 | 41.34 | 9.5 |
| 4 | 10 | 2 | 71.82 | 59.92 | 19 |

| **FLUSH THREAD SCREEN - PVC - SCHEDULE 40 *****SLOT SIZES .010, .020 & .030 ONLY***** | | | | | |
|--|----------------|----------|------------------|--------------------|-----------------|
| SIZE IN INCHES | LENGTH IN FEET | BOX QTY. | SINGLES NET EACH | BOX QTY** NET EACH | WEIGHT LBS. EA. |
| 1 | 5 | 6 | 24.28 | 17.30 | 1.4 |
| 1 | 10 | 6 | 35.68 | 25.27 | 3 |
| 2 | 2 1/2 | 6 | 23.51 | 20.35 | 1.5 |
| 2 | 5 | 6 | 31.35 | 25.69 | 3 |
| 2 | 10 | 6 | 37.16 | 32.18 | 6 |
| 4 | 2 1/2 | 2 | 47.18 | 42.26 | 4.5 |
| 4 | 5 | 2 | 82.42 | 55.52 | 9 |
| 4 | 10 | 2 | 92.85 | 78.56 | 18 |

**PLEASE SPECIFY SLOT SIZE .010 , .020 OR .030

**PLEASE SPECIFY SLOT SIZE
 SPECIAL SET UP CHARGE MAY APPLY

| FLUSH THREAD PLUGS OR CAPS | | | |
|----------------------------|----------|------------------|------------------|
| SIZE IN INCHES | BOX QTY. | SINGLES NET EACH | BOX QTY NET EACH |
| 1 | 20 | 7.64 | 5.93 |
| 2 | 20 | 9.70 | 7.56 |
| 4 | 20 | 18.27 | 13.61 |

PRICES ON MONOFLEX SUBJECT TO CHANGE WITHOUT NOTICE DUE TO VOLATILITY OF THE PVC MARKET

PAGE D - 6
 JUNE - 2010



LOCKING WELL PROTECTORS

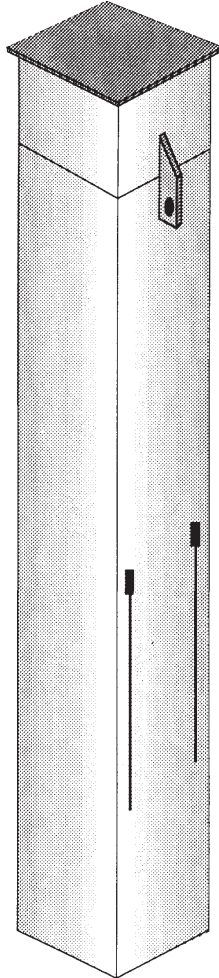

| SIZE SQUARE X LENGTH | NET PRICE |
|----------------------|-----------|
| 6" X 6" X 5' | 112.75 |
| 8" X 8" X 5' | 211.50 |

MANUFACTURED OF STRUCTURAL STEEL TUBING. HINGED CAP IS EQUIPPED WITH A LOCK LUG AND WILL ACCEPT A #3 MASTERLOCK. THIS UNIT IS COATED WITH AN EXTERIOR GRADE PRIMER AND HAS STABILIZATION BARS TO HELP DURING INSTALLATION.



LOCKABLE WELL PLUG

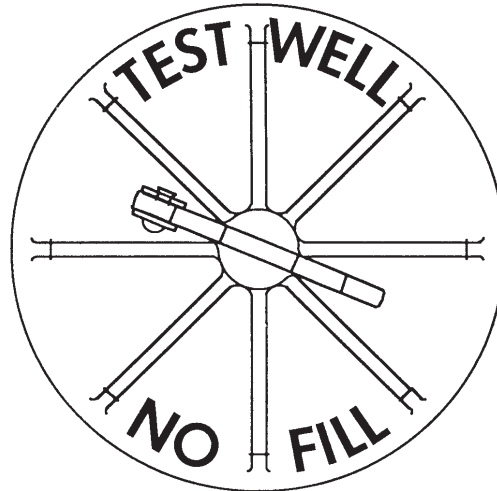

STAINLESS
STEEL
LOCK LEVER

BRASS BOLT

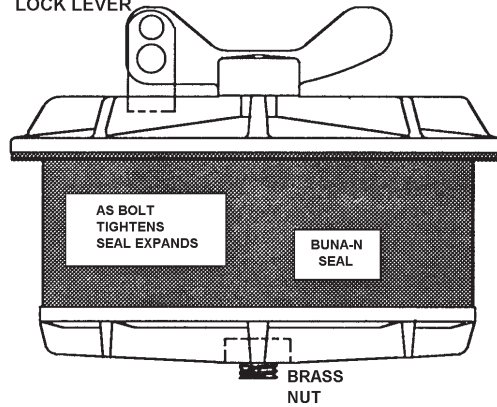

BRASS
NUT

| SIZE WELL CASING | NET PRICE |
|------------------|-----------|
| 2 INCH | 22.00 |
| 4 INCH | 25.30 |



MONITORING WELL MANHOLES NET PRICE



| LIMITED ACCESS MANHOLE LIMITED ACCESS WEATHER RESISTANT BUILT TO LAST | FIG. 418XA 8" X 12" 62.00 12" X 7" 82.50 18" X 12" 176.50 |   <table border="1" style="font-size: 8px; margin-top: 10px;"> <thead> <tr> <th>SIZE</th> <th>A</th> <th>B</th> </tr> </thead> <tbody> <tr> <td>8" X 7"</td> <td>9"</td> <td>7"</td> </tr> <tr> <td>12" X 7"</td> <td>12"</td> <td>7"</td> </tr> <tr> <td>12" X 12"</td> <td>12"</td> <td>12"</td> </tr> </tbody> </table> | SIZE | A | B | 8" X 7" | 9" | 7" | 12" X 7" | 12" | 7" | 12" X 12" | 12" | 12" |
|---|--|--|------|---|---|---------|----|----|----------|-----|----|-----------|-----|-----|
| SIZE | A | B | | | | | | | | | | | | |
| 8" X 7" | 9" | 7" | | | | | | | | | | | | |
| 12" X 7" | 12" | 7" | | | | | | | | | | | | |
| 12" X 12" | 12" | 12" | | | | | | | | | | | | |

FIG 418XA - CONSISTS OF A CAST IRON LID AND RIM, REPLACEABLE BUNA - N GASKET, GALVANIZED SHEET METAL SKIRT, AND STAINLESS STEEL BOLTS. LUGS ON INSIDE OF BODY RIM ARE THREADED FOR BOLTS TO DRAW LID DOWN TIGHT. BOLTED COVER PROVIDES WEATHERTIGHT SEAL AND "LIMITED ACCESS" FEATURE.

| | | |
|---|---|---|
| WATERTIGHT MANHOLE TRUE WATERTIGHT LIMITED ACCESS TOP-OF-THE LINE | FIG. 519 9" X 8" 173.00 12" X 9" 210.00 |   <p style="font-size: 8px; margin-top: 5px;"> 9" WEIGHT - 32LBS 12" (IRON LID) - 76LBS 12" (ALUM LID) - 66LBS </p> |
|---|---|---|

THE 519 SERIES CONSISTS OF A FULL-CAST, ONE-PIECE IRON BODY AND SKIRT, CAST IRON LID, BRASS SPIDER, REPLACEABLE BUNA-N GASKET, AND STAINLESS STEEL BOLT. A BRASS I.D. PLATE IS PROVIDED AND PERMANENT WARNING SYMBOL AFFIXED TO THE COVER. THE BEST OF THE LINE, MADE TO PROVIDE MANY YEARS OF SERVICE.

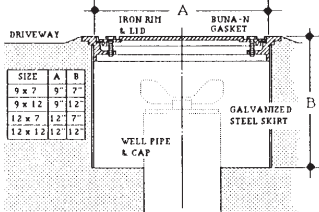

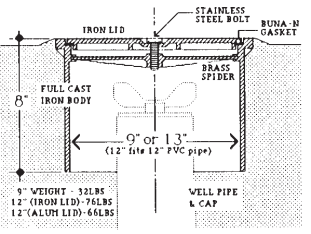
STAINLESS STEEL CENTRALIZER

STAINLESS STEEL CENTRALIZERS

| PIPE SIZE X MAXIMUM DIA. HOLE | NET PRICE |
|-------------------------------|-----------|
| 2" X 12" | 18.75 |
| 4" X 12" | 19.25 |
| 5" X 12" | 23.75 |
| 6" X 12" | 25.60 |

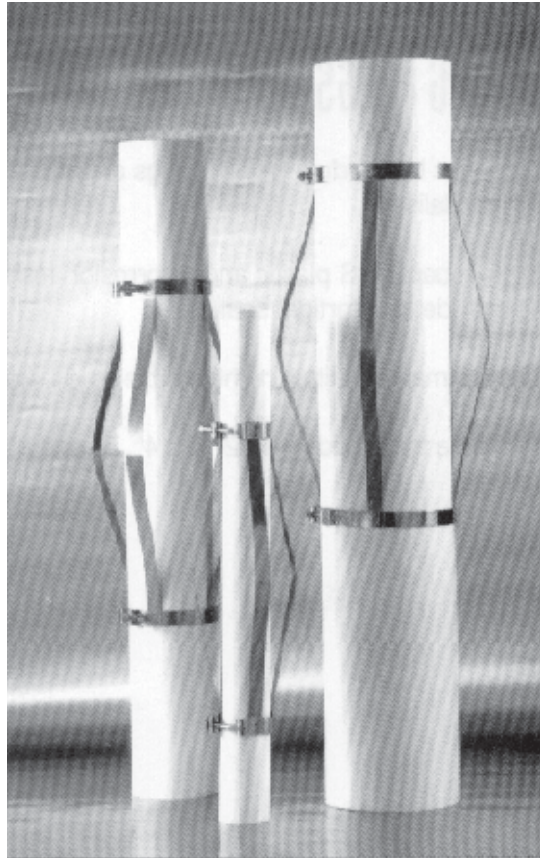

PAGE D - 10
SEPTEMBER - 2008



W - 6R DRAG BIT WINGS

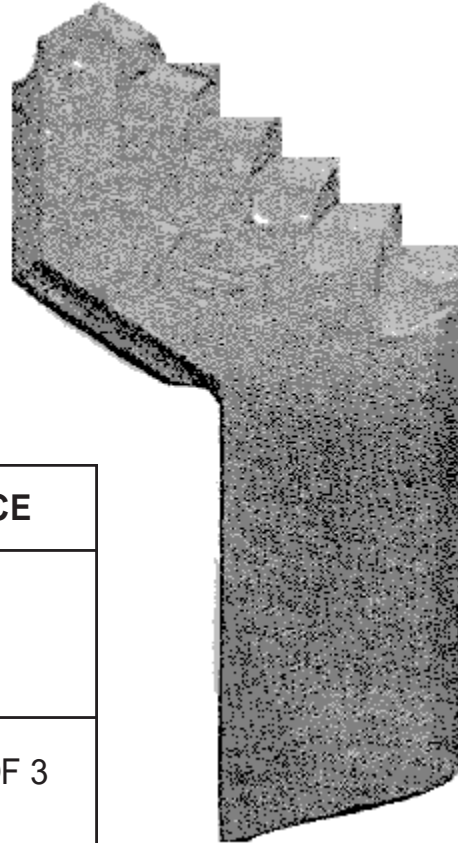

| SIZE | NET PRICE |
|---------|-----------|
| 10 5/8" | 325.00 |
| 12 1/4" | 365.00 |

NET PRICE IS FOR A SET OF 3 WINGS

*FOR PRICING ON OTHER DRAG BIT WINGS OR ASSEMBLIES, PLEASE CALL FOR A QUOTE.



PREMIER PUMP & SUPPLY, INC.
 PROVIDING YOU WITH THE VERY BEST SERVICE IN THE INDUSTRY!

**RECONDITIONED
 55 GALLON STEEL
 WASTE DISPOSAL DRUMS**

RECONDITIONED 55 GALLON REGULATED STEEL OPENHEAD DRUMS
 EXTERIOR IS PAINTED BLACK WITH WHITE COVER
 CLOSURE SYSTEM CONSISTS OF 2" BUNG & 3/4" VENT HOLE IN COVER,
 GASKET, 12 GAUGE BOLT RING, BOLT & NUT. THE BOLTS TO SECURE THE
 RINGS TO HOLD COVERS ON ARE STANDARD 12 GAUGE 5/8"
 ADHERES TO RULE 40 DOT REQUIREMENTS
 DRUMS MEET U.N SPECIFICATIONS 1A2/Y1.2/100

ORDER# DRUM

| | |
|--------------|-------|
| NET PRICE | 63.00 |
| ** QTY PRICE | 56.00 |

** QTY DISCOUNT 10 OR MORE
 STOCKED IN FRESNO ONLY



** NOT FOR USE WITH CAUSTIC OR CORROSIVE MATERIALS

PAGE D - 12
 DECEMBER - 2011